



ВСЕРОССИЙСКАЯ ФЕДЕРАЦИЯ САМБО

ПРОТОКОЛ ХОДА СОРЕВНОВАНИЙ

International tournament "Baikal Cup"



3-5 september 2018

Irkutsk (Russia)

В.К. СВ100 КТ. 5 участников

A

| | | | |
|---|-----------------------|-------------|---------------------|
| 1 | GUMENIUK Sergey | 11.06.1990g | Russian Federation, |
| 5 | CHULUUNJAV Bulgankhvv | 22.04.1978g | Mongoliya |
| 3 | TABAROV Aii | 25.06.1987g | Russian Federation |
| 7 | | | |

ФИНАЛ

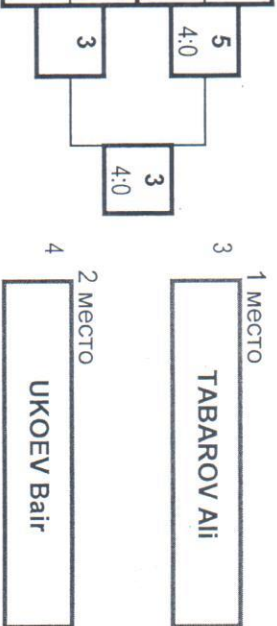

B

| | | | |
|---|------------------|-------------|--------------------|
| 2 | KURILSKIY Artyem | 04.02.1992g | Russian Federation |
| 6 | | | |
| 4 | UKHOEV Bair | 14.01.1985g | Russian Federation |
| 8 | | | |

A1

УТЕШИТЕЛЬНЫЕ ВСТРЕЧИ

B1

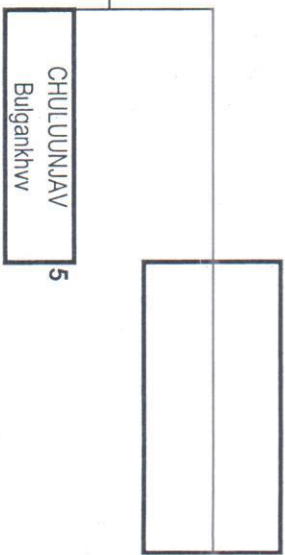
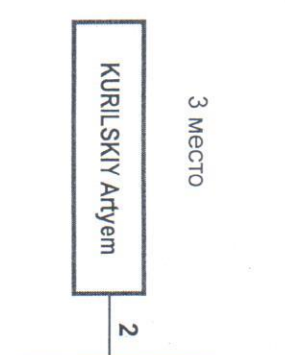
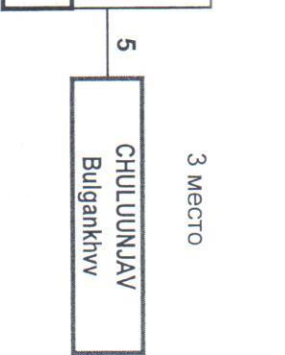
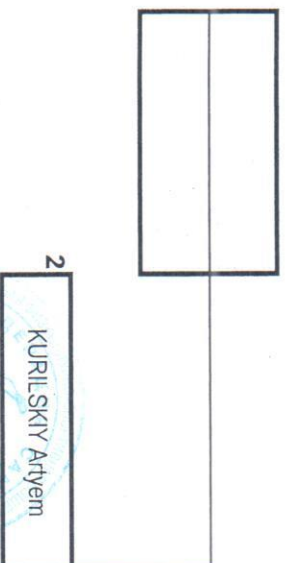

Chief referee

Chief secretary



KORNIENKO MAKSIM

/Russia/

SEYTABLAEV ALEXANDR

/Russia/



ВСЕРОССИЙСКАЯ ФЕДЕРАЦИЯ САМБО

ПРОТОКОЛ ХОДА СОРЕВНОВАНИЙ

International tournament "Baikal Cup"

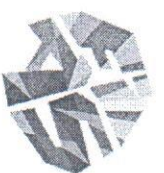

3-5 september 2018

Irkutsk (Russia)

В.К. 100 КТ. 5 участников

ФИНАЛ

| A | | | | Б | | | |
|---|------------------|-------------|--------------------|---------|------------------|-------------|--------------------|
| 1 | AGAFONOV Nikolay | 26.07.1983g | Russian Federation | 1 место | ANDRYSHKO Dmitry | 20.01.1992g | Russian Federation |
| 5 | BRUMM RUSLAN | 24.05.1993g | Germany | 2 место | BARANOV Andrey | 04.02.1982g | Russian Federation |
| 3 | PETROSYAN Sahak | 07.06.1996g | Armenia | 3 место | BARANOV Andrey | 04.02.1982g | Russian Federation |
| 7 | | | | | | | |

A1

УТЕШИТЕЛЬНЫЕ ВСТРЕЧИ

Б1

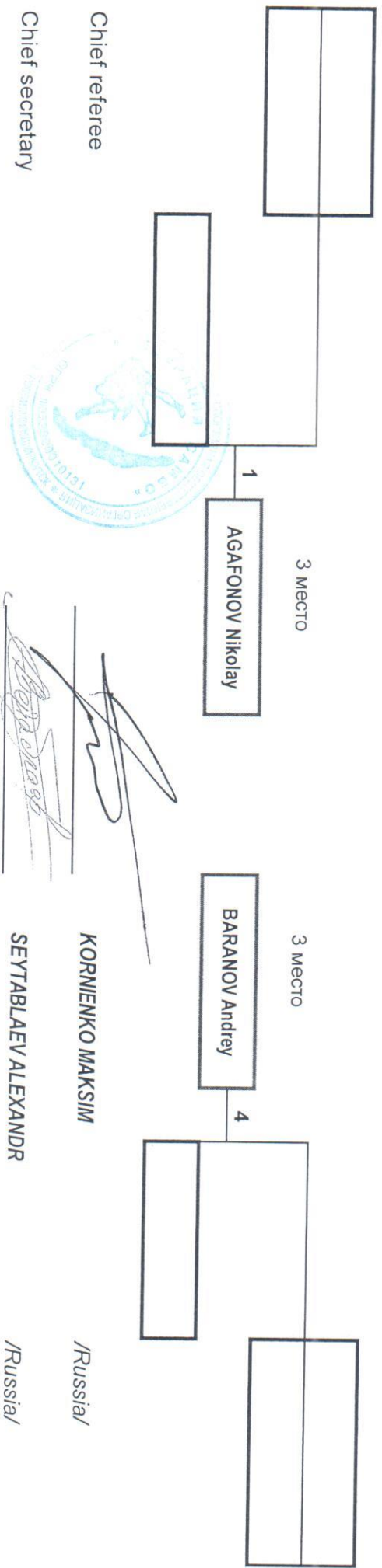

Chief referee

Chief secretary



Handwritten signatures of the officials

KORNIENKO MAKSIM

SEYTABLAEV ALEXANDR

/Russia/

/Russia/



ВСЕРОССИЙСКАЯ ФЕДЕРАЦИЯ САМБО

ПРОТОКОЛ ХОДА СОРЕВНОВАНИЙ

International tournament "Baikal Cup"

3-5 september 2018

Irkutsk (Russia)

В.К. 90 КГ. 6 участников

ФИНАЛ

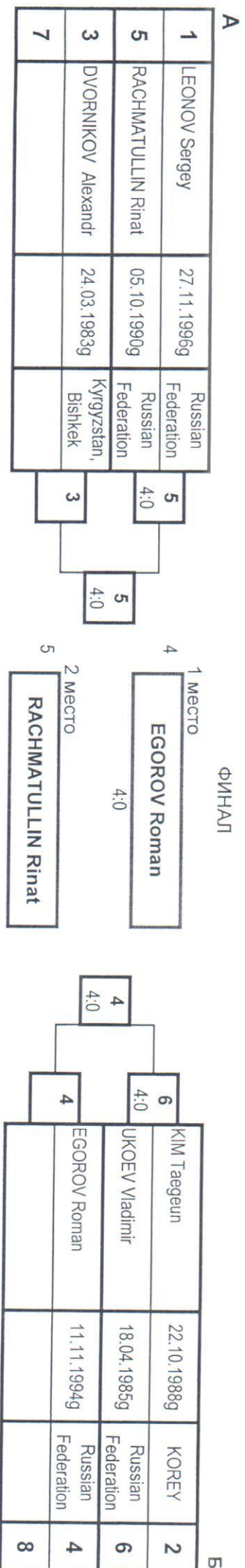

A1

УТЕШИТЕЛЬНЫЕ ВСТРЕЧИ

Б1

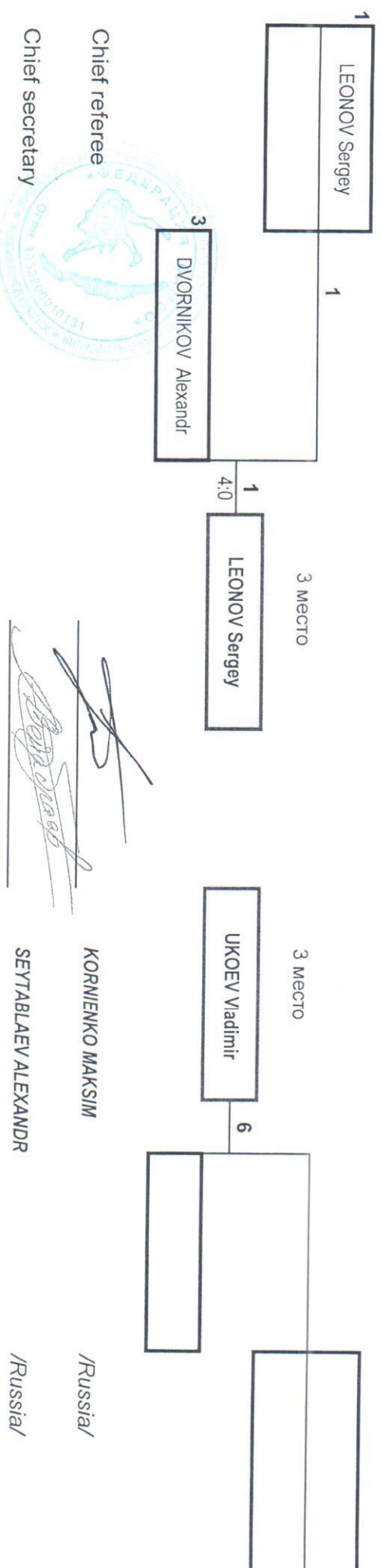



ВСЕРОССИЙСКАЯ ФЕДЕРАЦИЯ САМБО
ПРОТОКОЛ ХОДА СОРЕВНОВАНИЙ



International tournament "Baikal Cup"

3-5 september 2018

Irkutsk (Russia)

В.к. 82 кт.

7 участников

A

| | | | |
|---|----------------------|-------------|--------------------|
| 1 | GRACHOV Ivan | 03.12.1996g | Russian Federation |
| 5 | TLEKEYEV Serik | 11.10.1984g | Kazakhstan |
| 3 | ALEKSIYEVICH Yauheni | 28.02.1990g | Belarus, Minsk |
| 7 | KUZUKU Tarik | 21.04.1987g | Germany |

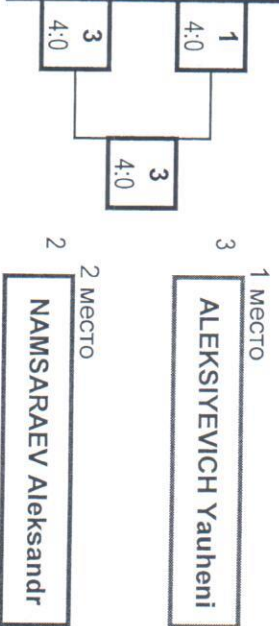

ФИНАЛ

| | | | |
|---|---------------------|-------------|--------------------|
| 2 | NAMSARAEV Aleksandr | 09.01.1994g | Russian Federation |
| 6 | HAFAEEZ Ullah | 01.01.1991g | Pakistan |
| 4 | ORDANYAN Hakov | 21.01.1993g | Armenia |
| 8 | | | |

A1

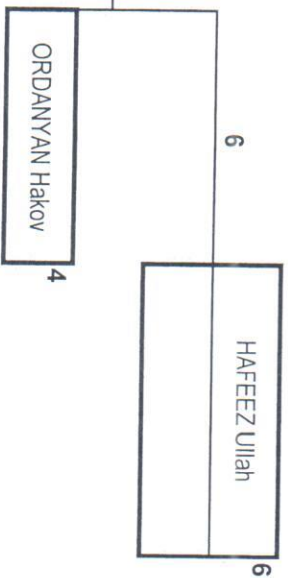
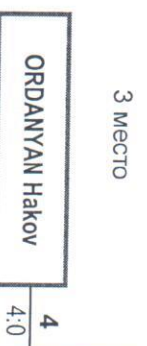
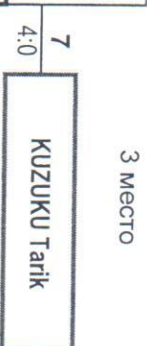
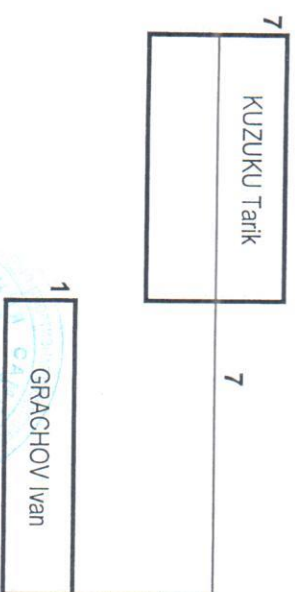

УТЕШИТЕЛЬНЫЕ ВСТРЕЧИ

B1

Chief referee

Chief secretary

KORNIENKO MAKSIM

/Russia/

SEYTABLAEV ALEXANDR

/Russia/





ВСЕРОССИЙСКАЯ ФЕДЕРАЦИЯ САНБО

ПРОТОКОЛ ХОДА СОРЕВНОВАНИЙ

International tournament "Baikal Cup"



3-5 september 2018

Иркутск (Russia)

В.К. 74 КТ.

14 УЧАСТНИКОВ

| A | | | | B | | | |
|----|----------------------|---------------|---------------------|----|---------------------|---------------|--------------------|
| № | Имя | Дата рождения | Страна | № | Имя | Дата рождения | Страна |
| 1 | ERDENEMUNKH Adiya | 07.11.1994g | Mongoliya | 2 | GANBAATAR Bat-Orgil | 18.08.1993g | Mongoliya |
| 9 | KESKIN Murat | 11.06.1986g | Germany | 10 | OMIRTAJEV Maxat | 05.06.1994g | Kazakhstan |
| 5 | SHMIDT Alexey | 02.04.1986g | Russian Federation | 6 | ZAITSEV Andrey | 05.01.1987g | Russian Federation |
| 13 | KONTIENG Siwa | 09.12.1988g | THAILAND | 14 | MANICAP Patrick | 12.11.1982g | Filipino |
| 3 | KOZLOVSKIY Michail | 16.09.1998g | Russian Federation | 4 | MAMEDOV Roman | 18.12.1991g | Russian Federation |
| 11 | PARPISHOEV Tabrezsho | 19.04.1993g | Tajikistan, Khujand | 12 | HONG Sunghov | 29.11.1986g | KOREY |
| 7 | ZHIGZHITOV Zhargal | 24.06.1989g | Russian Federation | 8 | ABBASOV Tariel | 16.01.1996g | Israel |
| 15 | | | | 16 | | | |

A1

УТЕШИТЕЛЬНЫЕ ВСТРЕЧИ

B1

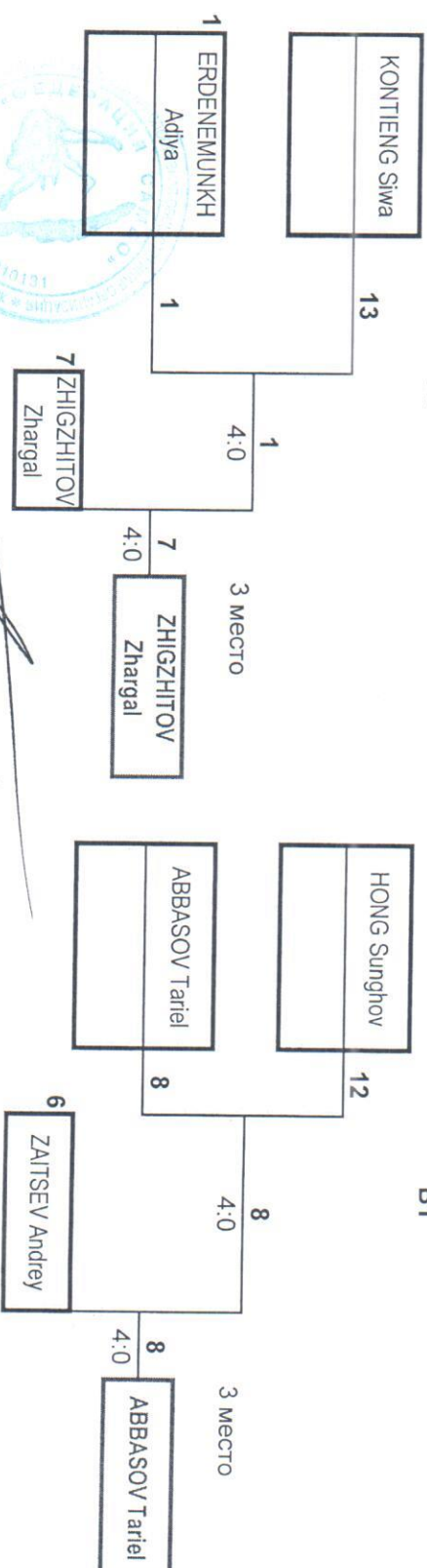

Chief referee

Chief secretary



(Signature)
KORNIENKO MAKS /Russia/
SEYTABLAEV ALEI /Russia/



International tournament "Baikal Cup"

3-5 september 2018

Irkutsk (Russia)

В.к. 68 кт.

13 УЧАСТНИКОВ

A

| | | | |
|----|-----------------------|-------------|---------------------|
| 1 | BUDANAEV Aldar | 08.01.1990g | Russian Federation |
| 9 | ASTAPETS Vasilii | 18.08.1993g | Belarus, Minsk |
| 5 | PENKOVICH Nikita | 17.10.1992g | Russian Federation, |
| 13 | ZHIGZHITOV Erdem | 19.09.1992g | Russian Federation |
| 3 | KUCHUK Alexandr | 05.04.1990g | Russian Federation, |
| 11 | BOLOTBEKUULU Olzhobai | 24.12.1992g | Kyrgyzstan, Bishkek |
| 7 | GRAF Pfilippwilhelm | 18.09.1992g | Germany |
| 15 | | | |

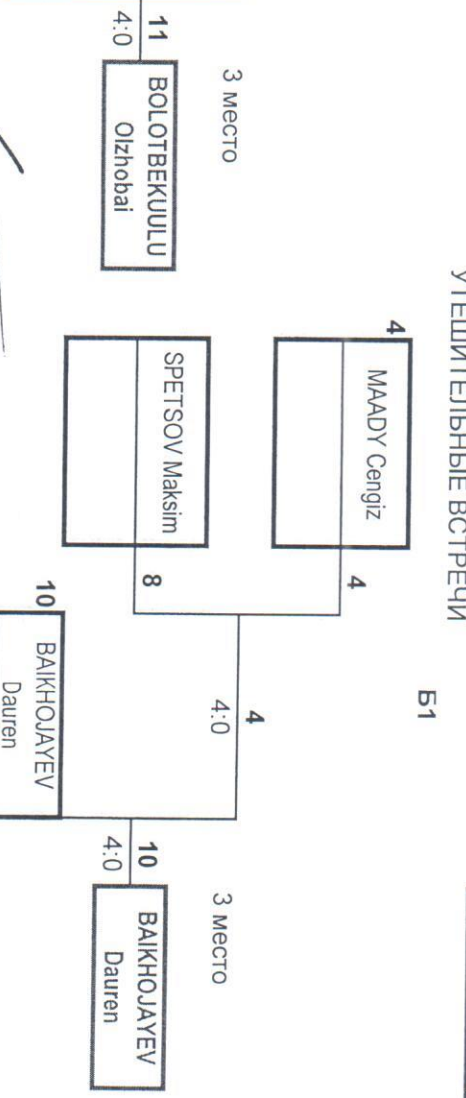
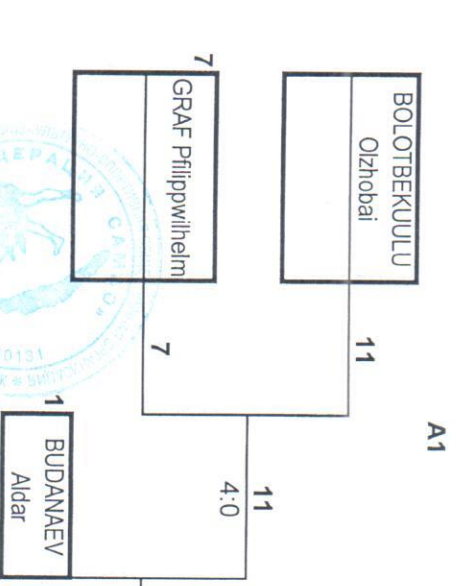
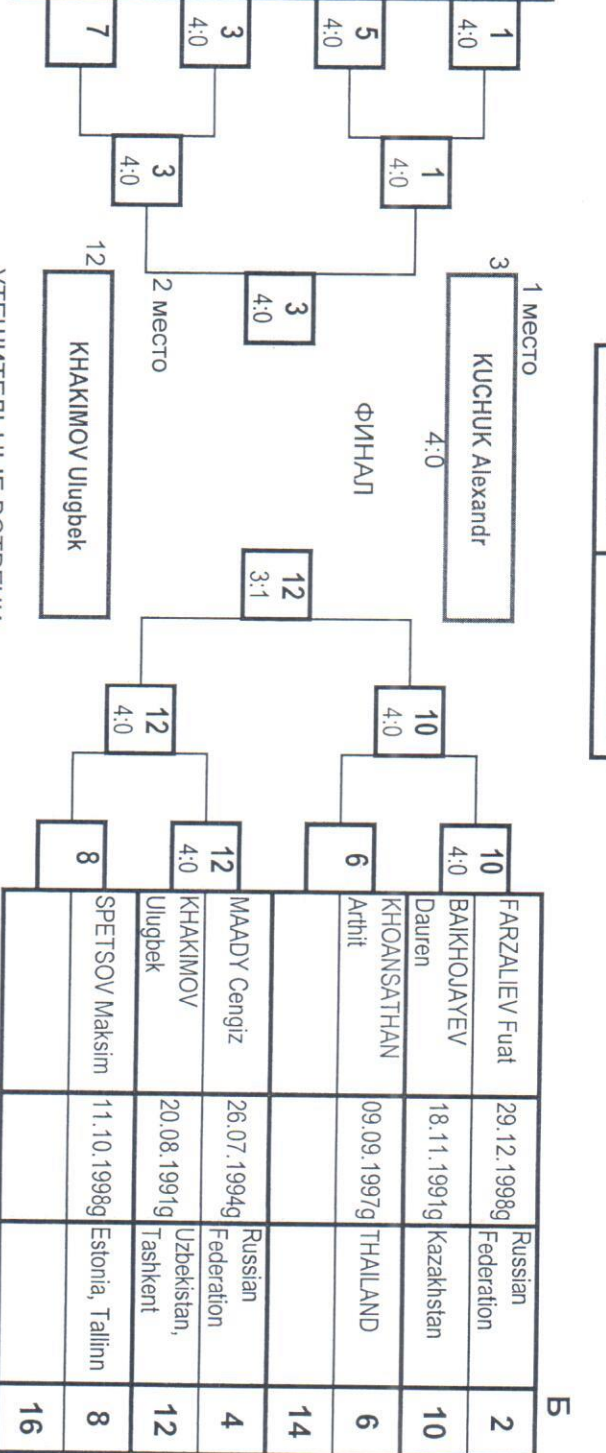

Chief referee

Chief secretary

[Signature]

KORNIENKO MAKSIM

/Russia/

SEYTABLAEV ALEXANDR

/Russia/



International tournament "Baikal Cup"

3-5 september 2018

Иркутск (Russia)

В.к. 62 кт.

14 УЧАСТНИКОВ



A

| | | | |
|----|------------------------|-------------|----------------------|
| 1 | BOKIEV Bohodir | 20.02.1988g | Russian Federation, |
| 9 | ISMATOV Sukhrob | 08.10.1997g | Tajikistan, Khujand |
| 5 | ODKHUU Batbayar | 05.06.1992g | Mongoliya |
| 13 | YETMISHBOEV Mukhtorjon | 02.03.1995g | Uzbekistan, Tashkent |
| 3 | LEONTEV Vladimir | 30.12.1997g | Russian Federation |
| 11 | SHAMOV Abdulzaub | 04.04.1998g | Kyrgyzstan, Bishkek |
| 7 | LAPYKO Gordey | 25.01.1990g | Russian Federation |
| 15 | | | |

A1

УТЕШИТЕЛЬНЫЕ ВСТРЕЧИ

B1

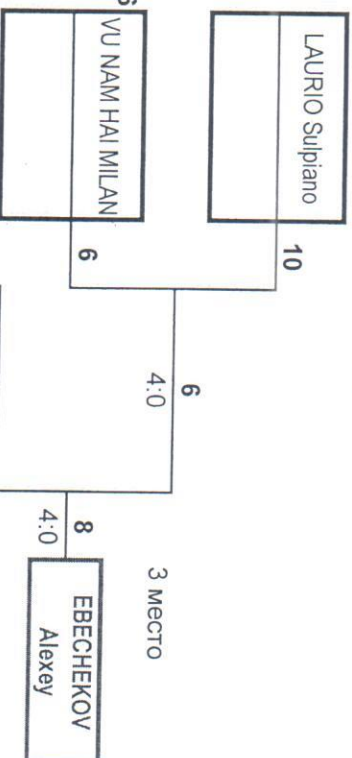
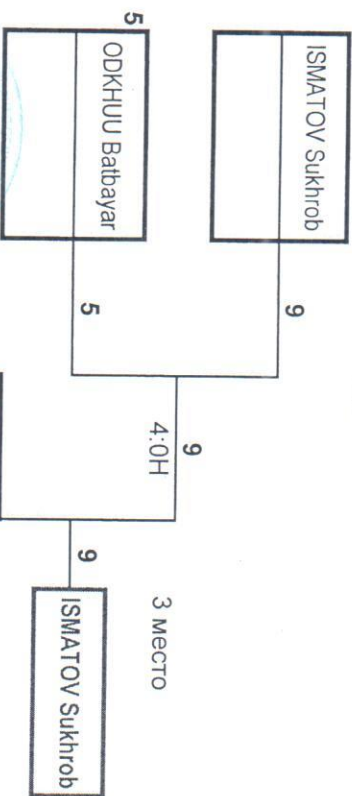
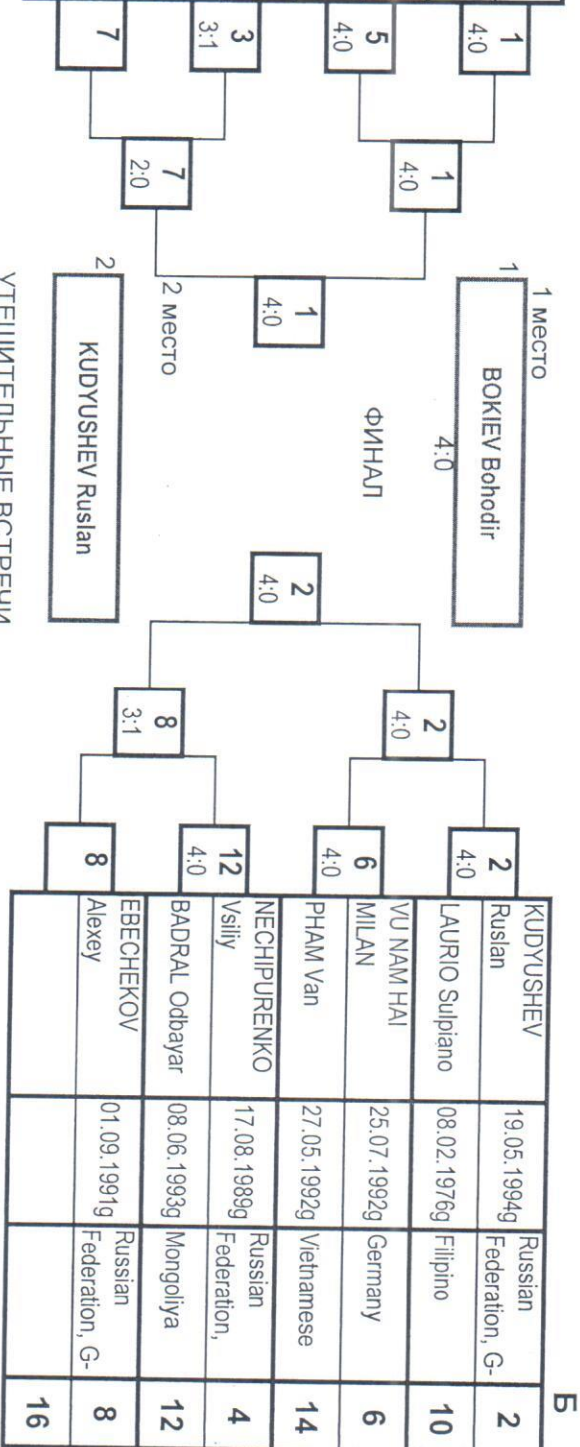

Chief referee

Chief secretary

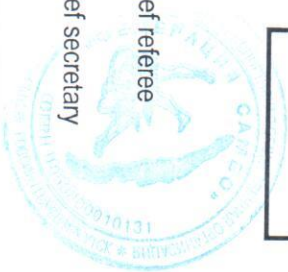

KORNIENKO MAKSIM

/Russia/

SEYTABLAEV ALEXANDR

/Russia/



International tournament "Baikal Cup"



3-5 september 2018

Irkutsk (Russia)

В.К. 57 КР.

10 УЧАСТНИКОВ

A

| | | | |
|----|--------------------------|-------------|---------------------------|
| 1 | KONZOSHEV Rustam | 22.08.1990g | Russian Federation, G- |
| 9 | CATALAN Rene | 12.12.1978g | Filipino |
| 5 | KANATBEK UULU Edilbek | 08.12.1992g | Kyrgyzstan, Bishkek |
| 13 | ERDYNEEV Sokto | 12.02.1991g | Russian Federation |
| 3 | | | |
| 11 | | | |
| 7 | KALI Abzal | 10.02.1994g | Kazakhstan |
| 15 | | | |

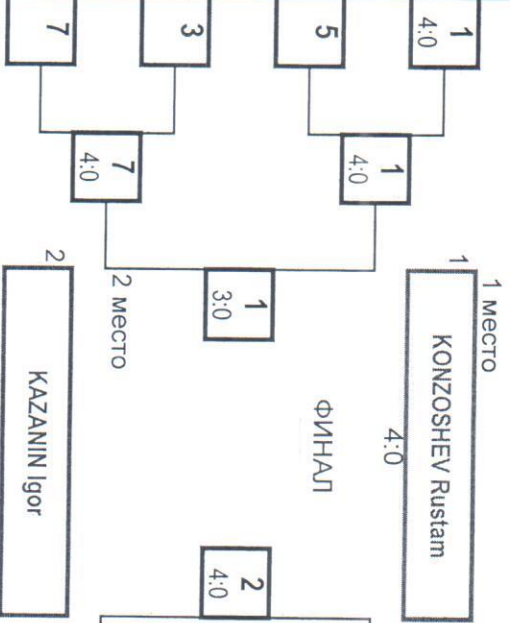

УТЕШИТЕЛЬНЫЕ ВСТРЕЧИ

B

| | | | |
|----|-----------------------|-------------|---------------------------|
| 2 | KAZANIN Igor | 11.03.1992g | Russian Federation, G- |
| 10 | SULEYMANOV Vail | 20.04.1999g | Russian Federation |
| 6 | OH Hyupcham | 13.09.1994g | KOREY |
| 14 | BOKIEV Muradulo | 02.04.1990g | Russian Federation, |
| 4 | | | |
| 12 | MKHITARYAN Mkhtiar | 25.04.1991g | Armenia |
| 8 | | | |
| 16 | | | |

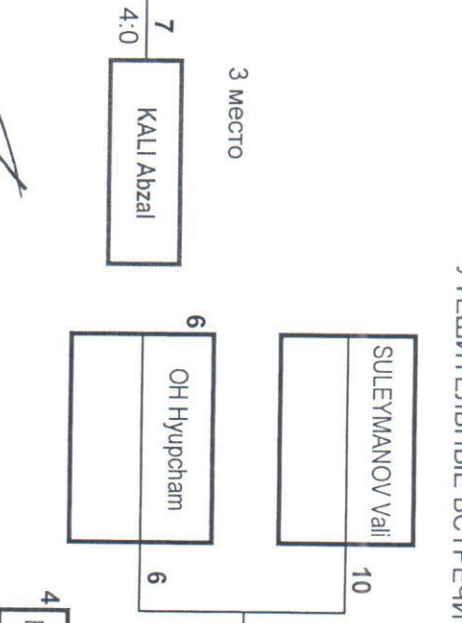
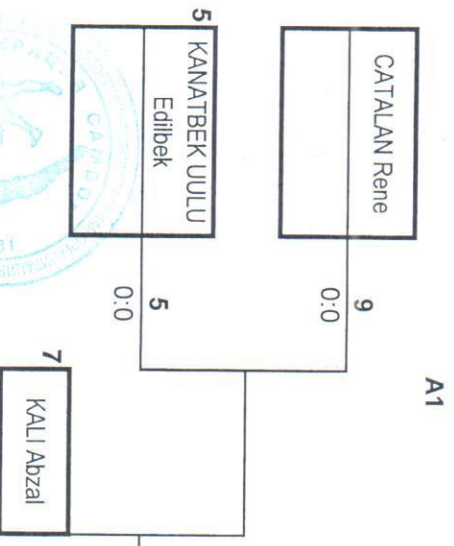

Chief referee

Chief secretary

KORNIENKO MAKSIM

/Russia/

SEYTABLAEV ALEXANDR

/Russia/

